

**EASY-LASER**<sup>®</sup>

www.easylaser.com

XT440



Shaft Alignment

**XT440**



IP66  
IP67



CLOUD  
CONNECTED

# MEASUREMENT INDEPENDENCE

## EASY-LASER® GENERATION XT

Easy-Laser® XT440 is the first member of our Generation XT alignment systems, built upon our cross-platform technology. You can now display the data on a multitude of different handheld devices, giving you the freedom to work with the gear that suits you the best. Simply download our straightforward XT application for free and you have all the measurement programs you need.

## NO LOCK-INS

With Generation XT you decide if you want the rugged and user-friendly Easy-Laser® XT12 display unit to be included or not. The app also runs on your iOS® or Android® device\*, be it a tablet or a phone, meaning you are never locked in to a specific way of working.

## NO LICENSE HASSLE

Your Generation XT measuring units determine what functions are available. No hassle with licenses, just connect the units to the app, on any of your display devices, and start measuring. That is straightforward!

## MAXIMUM FLEXIBILITY!

*The XT Alignment app runs on iOS and Android devices\*, as well as on the Easy-Laser® XT12/XT11 display unit. The choice is yours.*



\*Conditions apply

# HIGHLIGHTS

## MAXIMUM FLEXIBILITY



### ALL XT PROGRAMS IN ONE FREE APP

All XT measurement programs included in one straightforward application available for free.



### DISPLAY DATA ON MULTIPLE PLATFORMS

Functionality for iOS, Android and Easy-Laser® XT display units.



### NO LOCK-INS

Buy with or without the new user-friendly Easy-Laser® display unit.



### MAXIMUM FLEXIBILITY

Combine several measuring units with the display unit of your choice, or use different display units with one set of measuring units. No license hassle!



### RUGGED DESIGN

The XT products are rugged, rated both IP66 and IP67 water and dust proof. For superior durability in harsh environments.



### LONG OPERATING TIMES

The long operating times of up to 16 hours for the Display unit and 24 hours for the Measuring units means you will now be able to take on and finish the toughest jobs.

## ADD EXTRA POWER



### EASY-LASER PLUS™ IS OUR CLOUD SOLUTION WHERE YOU:

- Collaborate with your maintenance team on job assignments.
- Collect all your team's measurement data in one place for quick overview and analysis.
- Copy your measurement data to a new device if your tablet is lost or damaged.
- Restore accidentally deleted files on your tablet.
- Receive information about the latest software updates.

Simply put, Easy-Laser PLUS™ is your hub for the team's measurement jobs and extra security for your data. But that's not all...

Learn more at [easylaser.com](https://www.easylaser.com)

**EASY-LASER®**

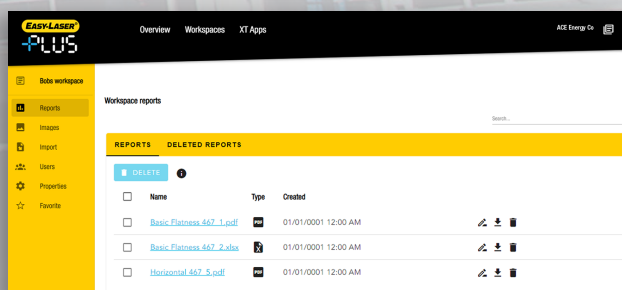

# THIS IS EASY ALIGNMENT

## HORIZONTAL PROGRAM



The user interface is intuitive and guides you through the measurement process. It is animated and zooms in to the relevant element for each step. You can save the measurements of a machine for *As found* and *As left* in the same file.

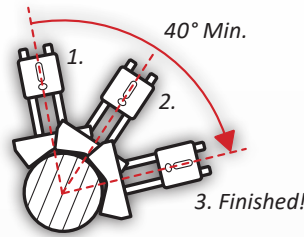

The EasyTurn™ function allows you to begin the measurement process from anywhere on the turn. You can turn the shaft to any three positions with as little as 20° between each position to register the measurement values. Voila! Measurement is complete!

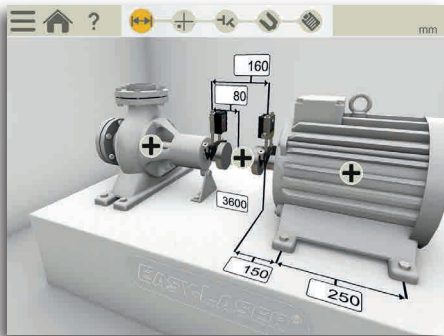

1. Enter dimensions



2. Measure (free positions or 9-12-3 o'clock)

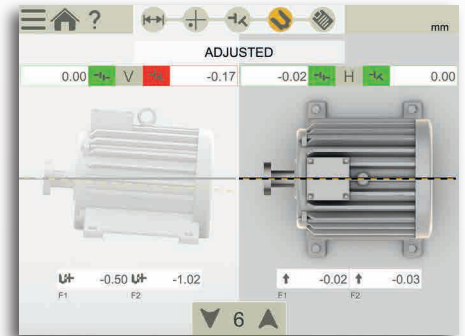

3. View result, *As found*  
4. Adjust

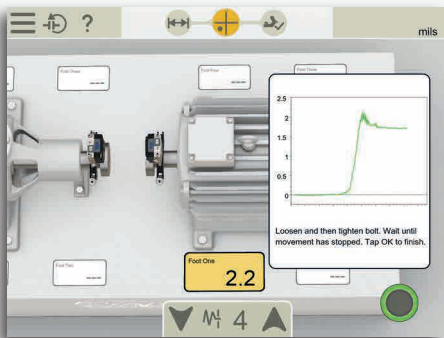

Soft Foot check on both machines

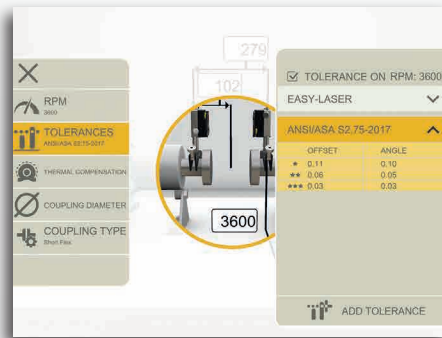

Tolerance check (pre-set or custom)

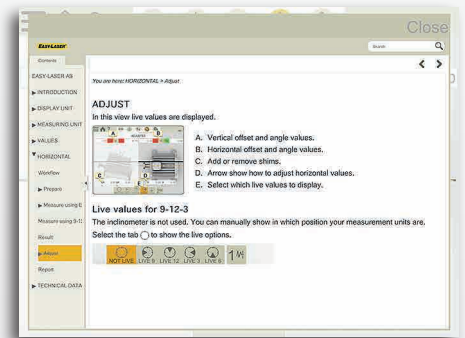

Easy-to-access built-in manual

## VALUES – DIGITAL DIAL INDICATOR



With the Values program you measure as with dial gauges, but with laser precision and the possibility to document the measurement result. You can also use it to check bearing play or shaft load.

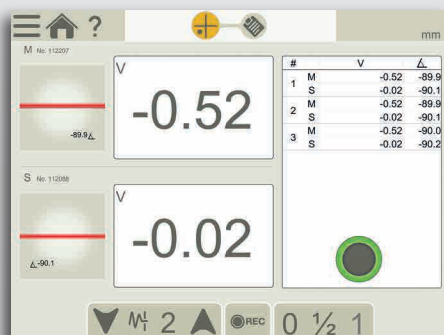

Values from measuring units

## VERTICAL/FLANGE MOUNTED MACHINES



For measurement and alignment of vertically and flange mounted machines. Handles machines with 4, 6, 8 and 10 bolts.

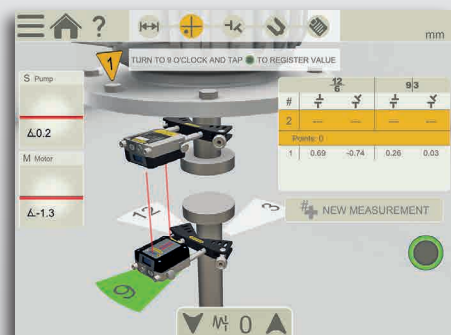

Program for vertically or flange mounted machines

# DOCUMENTATION

## SAVE!

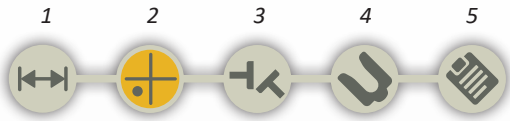

The interactive workflow indicator lets you easily jump to any part in the measurement process.



### BUILT-IN HELP

The app includes a searchable *Users Manual* which opens the relevant chapter depending where in the process you are. This makes it quick and easy to find the answer to your user questions.



### SELECT MACHINE IMAGE

Choose from different 3D machines to portray your machinery.



### SELECT COUPLING TYPE

Choose method depending on coupling type: short flex, spacer shaft.



### THERMAL GROWTH

Automatically compensate for thermal expansion of the machines.



### SWAP VIEW

Understand adjustment directions more intuitively.



### CONTINUE SESSION

Your latest measurement is always available, automatically saved.



### MEASUREMENT VALUE FILTER

Improve readings when measuring conditions are poor.



### MULTIPLE SETS OF FEET

Align machines with more than two pairs of feet.



### LOCKED FEET

Used when aligning base-bound or bolt-bound machines.



### TEMPLATES

Save measurement files as templates, with machine data and settings, to quickly start measurements.



### INTERNAL MEMORY

Save your measurement files, photos and reports to the internal memory.



### VERSATILE FILE TYPES

Both a PDF and an Excel file are generated.



### READ QR AND BAR CODES

Assign a specific code to a specific machine, then use the built-in camera of your device to open assigned file and settings.

*(Note: camera resolution requirements applicable.)*

## EXPLAIN!



### PDF REPORT TEMPLATES

Use one of the two formats included.



### ADD NOTES

Explain it a little more.



### SIGN REPORTS ELECTRONICALLY

Sign-on screen to verify your job. Signature is saved with the PDF file.



### ADD PHOTO

Show what you mean.



### ADD THERMAL IMAGE

See the difference after alignment.  
*(Available only with XT12 Part No. 12-1292)*

TYPE	NAME	DATE	Edit
[-]	Shaft_2018-02-14 14.21.05	2018-02-14	[Edit]
V.0.00 H.0.00	Values_2018-04-10	2018-04-10	[Edit]
[IMG]	IMG_20180410_142801	2018-04-10	[Edit]
[-]	Shaft Alignment Water pump 3	2018-04-10	[Edit]
[T]	Vertical motor ABB	2018-04-14	[Edit]

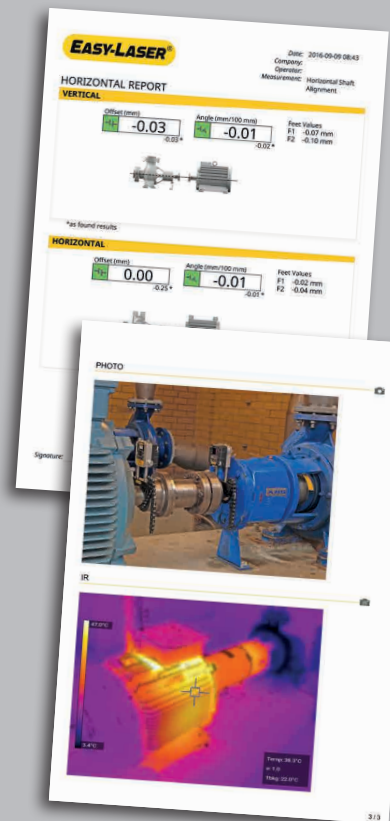

## SHARE!



### SEND THE REPORTS

Share the reports via email. Possible on all platforms.



### SAVE TO USB

Save your files to USB and copy to other devices.



# SYSTEM PARTS

## XT40-M/S MEASURING UNITS

The XT40 measuring units have a large 30 mm PSD, and a state-of-the-art OLED display (F) which shows the angle of the unit, making it easier to position it on the shaft. The line laser technology provides a fast setup and easy measurement process. The diagonally positioned locking knobs securely lock the unit on the rods. Rigid aluminium housing provide maximum stability. IP66 and 67, dust- water- and shockproof. Heavy-duty battery for very long operating times; up to 24 hours. Built-in wireless technology.

## SHAFT BRACKET

The V-bracket is both light yet rigid, with two rods for maximum stability in all directions. Pre-mounted chain for quick setup on the machine.



- A. Chain tightening knob
- B. Laser angle adjustment (only on M unit)
- C. Charger connector
- D. Laser aperture
- E. PSD aperture
- F. OLED display: battery status/unit angle
- G. Extendable stainless steel rods
- H. Locking knob

## XT12 DISPLAY UNIT

Rugged, robust, industrial grade tablet with wear resistant rubberized protective coating. IP66 and 67, dust- water- and shockproof. As standard a 13 MP camera for documentation is built-in, but you can also choose a model with IR camera added. With this you can shoot a thermal image before and after alignment and include with the documentation! A large 8", glove-enabled touch-screen makes the information clear and the app easy to use. You can check battery status also when the unit is turned off. Heavy-duty rechargeable battery for very long operating times; up to 16 hours. Fastening points for shoulder strap (included).



- A. Ergonomically, rubber coated housing
- B. Battery status-check button
- C. Battery status indicators
- D. Dust cover and protection for connectors (Note: connectors are dust and waterproof)
- E. Proximity sensor
- F. Display brightness sensor
- G. Large and clear 8" glove-enabled touch-screen
- H. Enter button

# RUGGED DESIGN



## IP66 AND IP67 APPROVED

Easy-Laser® XT measuring units and display unit are waterproof, dustproof and shockproof. The units have been tested and approved to an Ingress Protection rating of IP66 and IP67, which means that they are dustproof and waterproof to a depth of 1 metre, and also protected against powerful water jets.

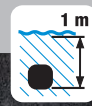
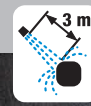

## ACCESSORY BRACKETS

Optional brackets for shaft alignment.

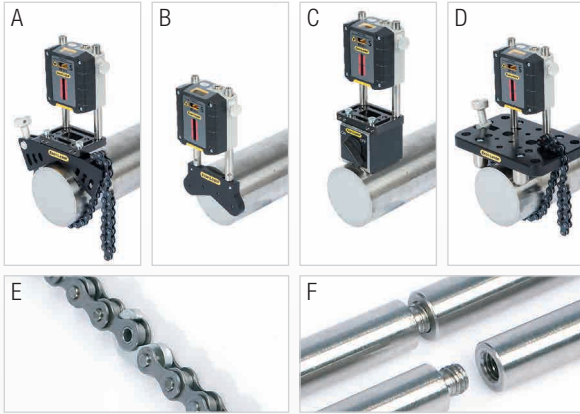

- A. Offset bracket, Part No. 12-1008
- B. Magnetic bracket, Part No. 12-1011
- C. Magnet base, Part No. 12-0013  
(Note: offset bracket also needed.)
- D. Sliding bracket, Part No. 12-1010
- E. Extension chain, Part No. 12-1060. Extends the chain for shafts up to diameter 450 mm [17.7"]
- F. Extension rods:  
Length 30 mm [1.18"], (x1) Part No. 01-0938  
Length 60 mm [2.36"], (x4) Part No. 12-0059  
Length 120 mm [4.72"], (x8) Part No. 12-0324  
Length 240 mm [9.44"], (x4) Part No. 12-0060



## THERMAL CAMERA

The Easy-Laser® XT12 can be delivered with a thermal imaging camera (IR) along with the standard 13 MP digital camera. Shoot a thermal image before and after alignment and include with the documentation!



## 13 MP CAMERA

Take pictures to identify your machines and include with your report.



## LED LIGHT

Light up the work area when ambient light is not enough.

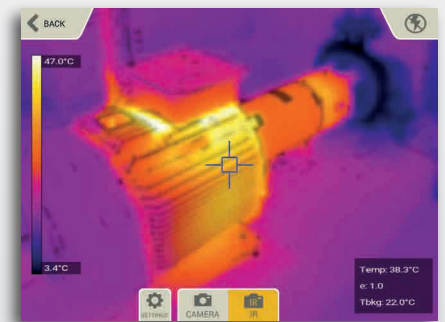

## AV CONNECTOR

As standard the XT12 is equipped with a HDMI connector, making it possible to share the display screen on a TV monitor or projector screen. Useful for training purposes with large groups.

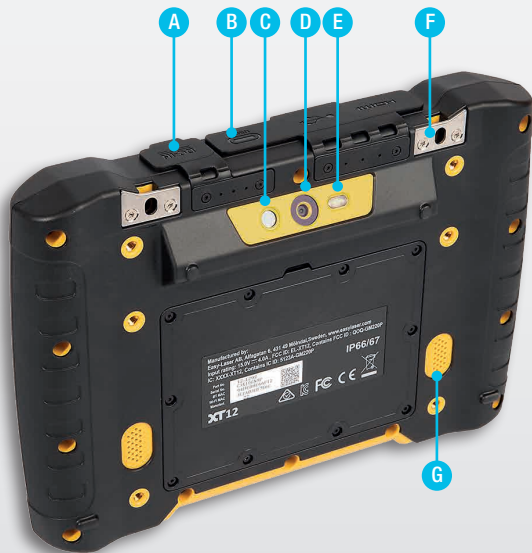

- A. Charger
- B. USB C / USB A / AV connector (HDMI)
- C. IR Camera (optional)
- D. 13 Mp Camera
- E. LED Light
- F. Fastening points for shoulder strap (x2)
- G. Loudspeakers

# XT440

**PART NO. 12-0966**

Weight: 6.0 kg [13.3 lbs]

Dimension WxHxD: 460x350x175 mm [18.1x13.8x6.9"]



*\*XT12 Display unit is added separately*

**The Easy-Laser® XT440 Shaft system include:**

1	Measuring unit XT40-M
1	Measuring unit XT40-S
2	Shaft brackets with chains and rods 120 mm [4.72"]
4	Rods 75 mm [2.95"]
1	Measuring tape 5 m [16.4']
1	Hexagon wrench set
1	Charger (100–240 V AC)
1	DC split cable for charging
1	DC to USB adapter, for charging
1	Quick reference manual
1	Cleaning cloth for optics
1	USB memory with manuals
1	Carrying case Medium

**Add display unit XT12:**

Part No. 12-1292	XT12 with IR Camera
Part No. 12-1291	XT12
Both are delivered with shoulder strap Part No. 12-0997	
Weight: 1490 g [52.5 oz]	

**Measuring units XT40-M / XT40-S**

Type of detector	TruePSD 30 mm [1.2"]
Communication	BT Wireless technology
Battery type	Heavy duty Li Ion rechargeable
Operating time	Up to 24 h continuously
Resolution	0.001 mm [0.05 mils]
Measurement accuracy	±5µm ±1%
Measurement range	Up to 10 m [33 feet]
Type of laser	Diode laser
Laser wavelength	630–680 nm
Laser class	Safety class 2
Laser output	<1 mW
Electronic inclinometer	0.1° resolution
Environmental protection	IP class 66 and 67
Operating temperature	-10–50 °C
Storage temperature	-20–50 °C
Relative humidity	10–95%
OLED display	128x64 pixels
Housing material	Anodized aluminium + PC/ABS + TPE
Dimensions	WxHxD: 76x76.7x39.3 mm [3.0x3.0x1.5"]
Weight	245 g [8.6 oz]

**Display unit XT12**

Type of display/size	8" LCD capacitive multi-touch colour display
Battery type	Heavy duty Li Ion rechargeable
Operating time	Up to 16 h continuously
Connections	USB A, USB C, Charger, AV
Communication	Wireless technology, WiFi
Camera, with LED diode	13 Mp autofocus
IR camera (optional)	FLIR LEPTON® (0–400 °C, 32–752 °F)
Languages	en / de / sv / es / pt / ru / ja / ko / zh / it / fr / pl / fi / tr
Help functions	Built-in manual
Environmental protection	IP66/67. Designed for outdoor use (pollution degree 4)
Operating temperature	-10–50 °C [14–122 °F]
Storage temperature	-20–50 °C [-4–122 °F]
Relative humidity	10–95%
Loudspeakers	Built-in, rear-facing
Charger	15 V
Housing material	PC/TPE or PC/TPU
Dimensions	WxHxD: 269.0x190.0x49.4 mm [10.59x7.48x1.95"]
Weight	1400 g [49.4 oz]

**Cable**

Charging cable (splitter cable)	Length 1 m [39.4"]
---------------------------------	--------------------

**Brackets etc.**

Shaft brackets	Type: V-bracket for chain, width 18 mm [0.7"]. Shaft diameters: 20–150 mm [0.8–6.0"] Material: anodised aluminium
Rods	Length: 120 mm, 75 mm [4.72", 2.95"] (extendable) Material: Stainless steel

Easy-Laser® is manufactured by Easy-Laser AB, Alfagatan 6, SE-431 49 Mölndal, Sweden  
 Tel +46 31 708 63 00, Fax +46 31 708 63 50, e-mail: info@easylaser.com, www.easylaser.com  
 © 2024 Easy-Laser AB. We reserve the right to make changes without prior notification.  
 Easy-Laser and Easy-Laser PLUS are registered trademarks of Easy-Laser AB. Android, Google Play, and the Google Play logo are trademarks of Google Inc. Apple, the Apple logo, iPhone, and iPod touch are trademarks of Apple Inc., registered in the U.S. and other countries. App Store is a service mark of Apple Inc. Other trademarks belong to their respective owners. Documentation ID: 05-0830 Rev11

